

### RZ3566SFL

Surface Mounted Floodlight With Die-casting Aluminum, Anti-Corrosion, Transparent Toughened Glass Led 35W 2800lm CRI80 220VAC D238\*H240mm 50.000h IP66



### RZ4566SFL

Surface Mounted Floodlight With Die-casting Aluminum, Anti-Corrosion, Transparent Toughened Glass Led 45W 3600lm CRI80 220VAC D238\*H240mm 50.000h IP66

### Description

Outdoor floodlight designed to use LED lamps and a spot optic. Consists of an optical assembly and a base.

Housing: Die-casting Aluminum, Anti-Corrosion, No-Rinse surface treatment. Surface with double layer fluorine carbon spraying and optimised for reduced accumulation of dirt, with a high level of weather resistance, UV-resistant. All external screws used are made of A2 stainless steel. Silicone sealing ring ensures resistance to temperature and aging.

Base is suitable for long-term contact with the ground and has corrosion resistance. Special structure which can adjust 15 degree by vertically and horizontally realized by two fixed points, and it is easy to operate and securely installed; All core parts are in the upper space of upright, there is 130mm height for brackets and fitting parts, no influences on upright for water lower than 130mm.

Luminaire head with transparent toughened non-reflective glass, resist the impact and friction.

With external 30 degree Integrated hood and internal anti-glare solution, this upright also provides round-meshed grill, honeycomb grill, textured glass to get the "only lighting no lamp" effect.

Control gear: 1 cable entries. [2] 3-pole terminal block.

LED module: High-power LEDs on metal-core PCB. Collimating lens made of optical Polymethyl. Tender and soft light to perfectly present the object without black spot and dark area.

Dimming driver can be optionally sold separately: Dali, 0-10V, Triac, Wireless.

Protection mode IP66: dust-proof and water jet-proof.

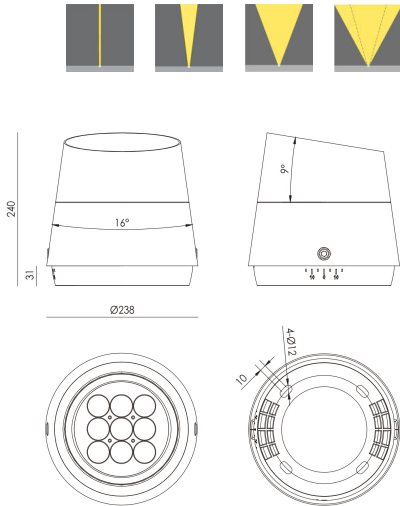

### Technical data

Light source	LED COB	
System Wattage	35W	45W
Luminous flux	2800lm	3600lm
Number of led lamp	9 Led	9 Led
Luminous efficiency	80lm/w or option	
Colour Temperature	2700K, 3000K, 4000K, 6000K, [RGB]	
Colour Rendering Index	CRI>80, [CRI>90]	
Colour Deviation	SDCM<3	
Beam Angle	2.5°, 3.5°, 6°, 12°, 20°, 30°, 45°, 60°, [10x70°]	
Rotation Angle	30° Swivel	
Anti-glare Rating	UGR<13	
Service Lifetime	50.000 Hrs L80 B20 Ta35	
Ingress Protection	IP66	
Operation Voltage	100-264VAC, 50Hz	24VDC
Operation Temperature	-30°C ~ 50°C	
Frame	Aluminum	
Finishing	Dark Grey, Matt Black or Option	
Lighting control (option)	Dali, 0-10V, Triac, Wireless, DMX512	

### Accessories

-

### Notes

-

