

RZ1266SLB

Floodlight With Die-casting Aluminum, Anti-Corrosion, Transparent Toughened Glass Led 12W 960lm CRI80 D95mm 50.000h IP66 with Grey Color

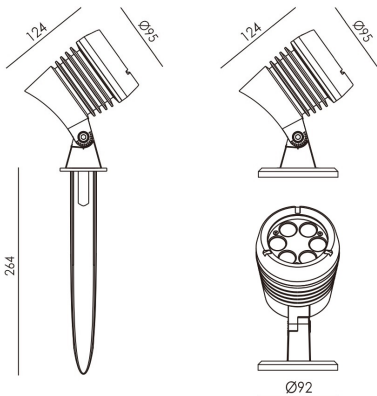

RZ1666SLB

Floodlight With Die-casting Aluminum, Anti-Corrosion, Transparent Toughened Glass Led 16W 1280lm CRI80 D95mm 50.000h IP66 with Grey Color

Description

Outdoor floodlight designed to use LED lamps and a spot optic. Consists of an optical assembly and a base.

Housing, hinge and mounting plate: Die-casting Aluminum, Anti-Corrosion, No-Rinse surface treatment. Surface with fluorine carbon spraying and optimised for reduced accumulation of dirt, with a high level of weather resistance. Hinge with 130° tilt. Mounting plate rotatable through 350°.

All external screws used are made of A2 stainless steel. Luminaire head with transparent toughened non-reflective glass, resist the impact and friction.

Control gear: 1 cable entries. [2] 3-pole terminal block.

LED module: High-power LEDs on metal-core PCB. Collimating lens made of optical Polymethyl. Tender and soft light to perfectly present the object without black spot and dark area.

Dimming driver can be optionally sold separately: Dali, 0-10V, Triac, Wireless.

Protection mode IP66: dust-proof and water jet-proof.



Technical data

Light source	LED COB
System Wattage	12W 16W
Luminous flux	960lm 1280lm
Number of led lamp	6 Led 7 Led
Luminous efficiency	80lm/w or option
Colour Temperature	2700K, 3000K, 4000K, 6000K
Colour Rendering Index	CRI>80, [CRI>90]
Colour Deviation	SDCM<3
Beam Angle	8°, 15°, 20°, 30°, 45°, 60°, [15x30°], [10x60°]
Rotation Angle	130° Tilt 350° Swivel
Anti-glare Rating	Accessory options
Service Lifetime	50.000 Hrs L80 B20 Ta35
Ingress Protection	IP66
Operation Voltage	100-240VAC, 50Hz 24VDC
Operation Temperature	-30°C ~ 50°C
Frame	Aluminum
Finishing	Dark Grey, Matt Black or Option
Lighting control (option)	Dali, 0-10V, Triac, Wireless

Accessories

Ground Spike & Honeycomb can be optionally sold separately

Notes

-

